

HOWES DC2000 Instructions

Caution

The DC2000 receiver and the band module(s) supplied with it are separate kits. Please take care not to mix them up! The part numbering starts at R1, C1 etc. in each kit, so be sure not to start putting the parts from one kit into another kit's board by mistake!

Overview of the DC2000 project

The **HOWES DC2000** is an amateur radio receiver in kit form. It can cover all the shortwave (HF) bands by means of plug-in band modules. One band module kit is supplied with the DC2000 (80M band as standard, others to special order). Any frequency between 1.8 to 30MHz can also be received with the appropriate additional module. The DC2000 is a "direct conversion" type receiver suitable for SSB, CW and related modes, and is compatible with many other HOWES KITS including ATUs, "S meter", audio filters, digital frequency displays and transmitters.

Brief Technical Details

Frequency Coverage: Determined by the band module in use. A nominal 50pF tuning capacitor is required to tune the receiver (supplied in HA22R hardware pack and available separately)

Semiconductors: One transistor, two diodes and three integrated circuits on main PCB.

Sensitivity: -118dBm (about 0.3µV) for 10dB Signal/Noise in audio bandwidth (-6dB) of 2.6kHz.

Audio output: Up to 1.2W into 8 Ohms (for loudspeaker or headphones).

Power required: 10 to 15 Volts DC, supply rated at 200mA or more. Approx. 22 mA quiescent, about 180mA at 1W output at 13.5V DC.

Tools Required

Small tipped soldering iron of about 25W rating, small side cutters, wire strippers, long nosed pliers and a trimming tool for the oscillator coils.

Building The Kit

Please read all the paperwork through at least once *before* starting work.

Make sure you have all the parts and tools to hand - if you don't have a small tipped iron suitable for modern electronic circuitry, then buy one, or borrow one from someone at the local radio club!

Terminal Pins

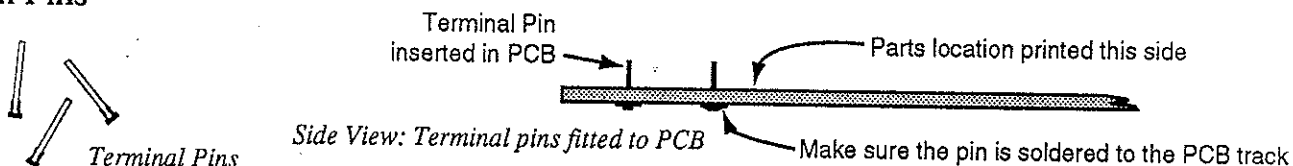

Terminal Pins need to be fitted to some of the Printed Circuit Board (PCB) holes to make it easier to wire the external connections. These are inserted into the holes shown in the diagram on the right. They have circles printed around them, so they are quite easy to find. The pins are inserted from the track (foil) side of the board and after fitting should project from the component side (the side with the printed parts locations). Push the pins into the holes by hand, and then resting the board over the edge of the bench, use a hot soldering iron and a little solder to push the pins fully home, flush into the board. **Be careful** not to slip with the hot iron as you do this. When all the terminal pins have been fitted check that they are all soldered to their PCB tracks (see soldering notes for guidance) and then move on to fitting the resistors.

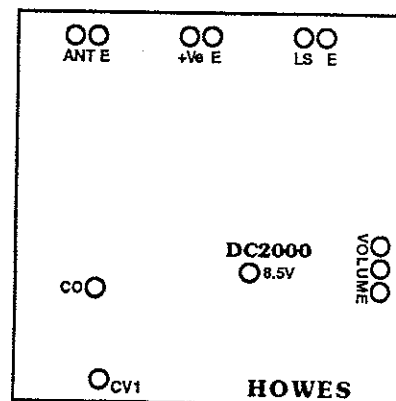

Top View: terminal pins holes

DC2000 Instructions, continued

Resistors

Refer to the Parts List, and select the first resistor from the top of the list. Bend its leads as shown in the diagram, and fit them into the holes marked for them on the circuit board. Be careful that you do not confuse the slightly larger axial inductor with the resistors. All the resistors have a light straw coloured background body colour with a gold band at one end.

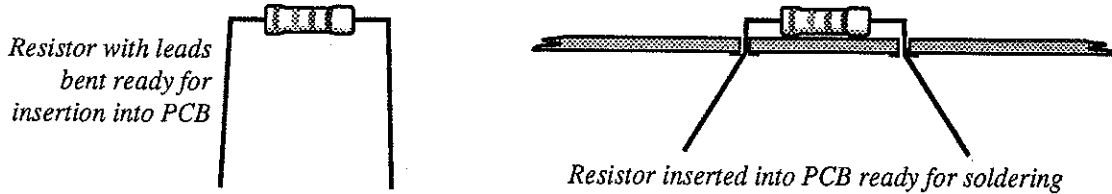

When you have inserted the resistor's leads into their holes, push the body of the component down onto the circuit board, and then bend the ends of the leads out slightly to hold the resistor in place. Then turn the PCB over and solder the leads to the printed circuit tracks. Make sure the resistor's body is flat against the board so that its leads are kept as short as possible. Please read the notes on soldering on page 4. Poor soldering is the most common cause of a kit failing to work first time, so please take the soldering advice to heart!

Cut the excess length of component lead off as close to the joint as possible *after* you have soldered it. Now fit the next resistor from the parts list in a similar manner, and then carry on down the parts list until all the resistors are fitted.

Axial Inductor (L2)

This component looks just like a fat resistor, but it has a blue or green background colour to its body. Inside the device is a small coil wound on ferrite material. In the band modules, the axial inductors form part of the band-pass RF filters. On the receiver board, L2 acts as an RF "choke". Fit this to its designated place on the board in the same way you fitted the resistors.

Diodes

Fit the diodes next, these must go the right way round. There is a band at one end of each diode's body - this indicates the lead that must go to the hole marked "+" on the board. D1 is the larger of the two diodes.

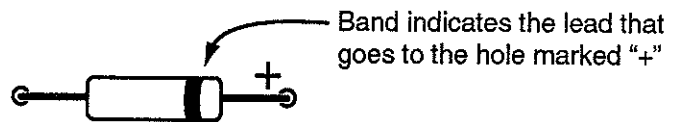

Capacitors

When the diodes are soldered in place, move on to the capacitors. When fitting these, be sure to keep their leads as short as possible.

Notes: the "electrolytic" type capacitors must be fitted the right way round - see note on the Parts List 2 page. There are two different types of .1µF capacitor in this kit (brown disc shape and rectangular green ones). Please be careful to select the correct part.

Transistor and Integrated Circuits

Select and fit the transistor, TR1, followed by the integrated circuits, IC1, IC2 & IC3 - again these must be fitted the right way round as shown on the diagrams.

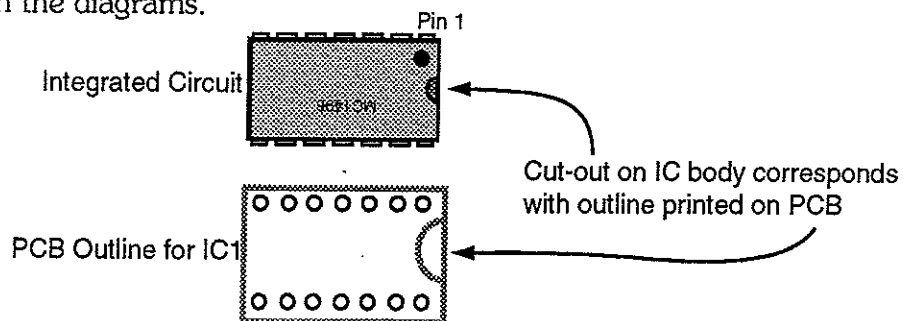
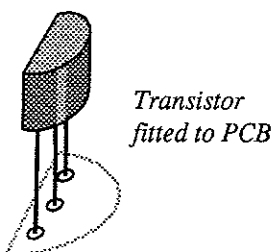

DC2000 Parts List 1

Resistors

| Value | Colour Code | | | Part Numbers |
|--------|-------------|--------|--------|------------------|
| ✓ 2R2 | Red | Red | Gold | ✓ R20 |
| ✓ 56R | Green | Blue | Black | ✓ R3 ✓ R21 ✓ R22 |
| ✓ 390R | Orange | White | Brown | ✓ R5 ✓ R6 |
| ✓ 820R | Grey | Red | Brown | ✓ R8 |
| ✓ 1k0 | Brown | Black | Red | ✓ R7 ✓ R15 ✓ R23 |
| ✓ 1k2 | Brown | Red | Red | ✓ R10 |
| ✓ 2k2 | Red | Red | Red | ✓ R9 ✓ R12 |
| 2k7 | Red | Violet | Red | R2 R11 |
| ✓ 4k7 | Yellow | Violet | Red | ✓ R17 ✓ R18 |
| ✓ 8k2 | Grey | Red | Red | ✓ R4 |
| ✓ 10k | Brown | Black | Orange | ✓ R1 ✓ R19 |
| ✓ 33k | Orange | Orange | Orange | ✓ R13 ✓ R14 |
| ✓ 100k | Brown | Black | Yellow | ✓ R16 |

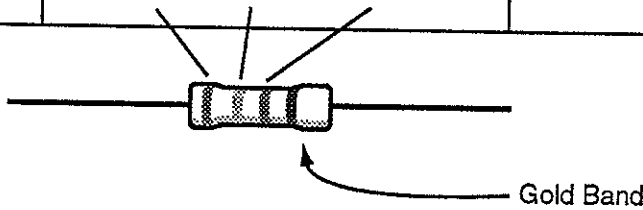

Axial Inductor, L2

✓ 220µH colour coded: Red, Red, Brown, Silver. This looks like a fatter resistor.

Diodes - take care to put these in the right way round.

D1 - This is a 1N4004 and has its type number marked on it. D2 - This is a BZX55 zener diode. It is a little smaller than D1 and has BZX and its voltage (9V1) marked on it.

The body colour of the 1N4004 and BZX55 diodes is usually black with a grey or silver coloured band.

Capacitors

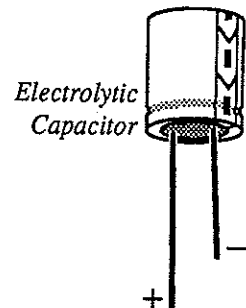
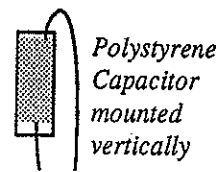
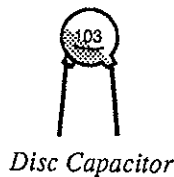
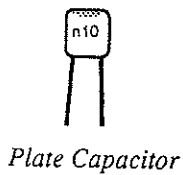

| Value | Marking | Part Numbers |
|-----------|------------------------------|--------------------------------|
| ✓ 1nF | Disc marked 102 | ✓ C13 ✓ C22 |
| ✓ 0.01µF | Disc marked 103 | ✓ C1 ✓ C2 ✓ C3 ✓ C6 ✓ C9 ✓ C17 |
| ✓ 0.1µF | Disc marked 104 | ✓ C7 ✓ C25 ✓ C26 |
| ✓ 0.047µF | Multi-layer plate marked 473 | ✓ C5 |
| ✓ 4.7nF | Mylar, green marked 472 | ✓ C4 ✓ C8 ✓ C11 ✓ C19 |
| ✓ 1µF | Mylar, green marked 104 | ✓ C10 ✓ C14 ✓ C16 ✓ C18 |
| ✓ 1µF* | Electrolytic marked 1µF | ✓ C12 |
| ✓ 100µF* | Electrolytic marked 100µF | ✓ C15 ✓ C20 ✓ C21 ✓ C23 ✓ C24 |

* Electrolytic capacitors must be fitted the right way round. The longer lead goes to the hole marked "+", the other lead goes to the "-" hole and is indicated by a band containing "-" signs on the side of the capacitor.

DC2000 Parts List 2

Transistor, TR1

This is a BC547B device. It has its type number marked on it. Insert it into the PCB the right way round as the outline printed on the board indicates.

Integrated circuits (chips).

IC1 is an MC1496 double balanced mixer.

IC2 is a TL071 "operational amplifier (op-amp)"

IC3 is an audio output amplifier, type TBA820M.

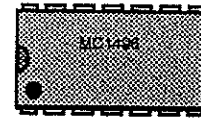

Mixer "Chip"

Make sure you fit the "chips" the right way round - as indicated by the outlines printed on the PCB.

Mixer Input Transformer: L1

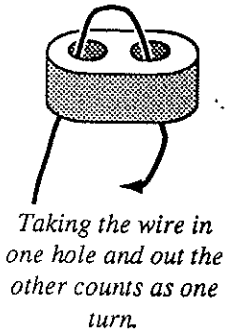

Wind eight turns of the thin yellow wire supplied neatly and tightly onto the two hole balun core. Passing the wire through one hole and then back out of the other counts as one turn. Do this eight times for eight turns. Both ends of the wire should project from the same side of the balun core (see diagram). When this is done, wind two turns of the red wire on top. The ends of the red wire should project from the same side of the balun core as the yellow wires. After the windings are complete, strip the insulation from the ends of the wires and insert them into the PCB holes marked for L1. The yellow wires go to the centre two holes, and the red wires to the outer two holes. When L1 is neatly in place, solder its wires to their PCB tracks.

Plug-in Band Module Connectors

PL1 and PL2 are PCB mounting 6 pin plugs and form the connectors for the plug-in band module. These are fitted with the plastic flange that runs along side the contacts facing towards the centre of the circuit board as shown in the diagram.

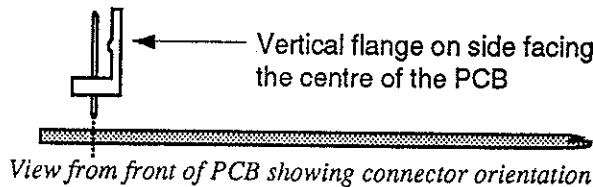
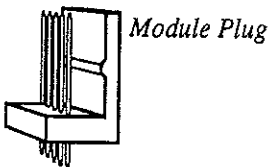

Notes On Soldering

To solder properly, you must use the correct type of iron and the right quality of solder. Use a small tipped soldering iron which has a bit that is short and almost pointed at the end. The iron should be about 25 Watts (if it is not thermostatically controlled). Only use electronic type multicored solder. NEVER use any extra flux.

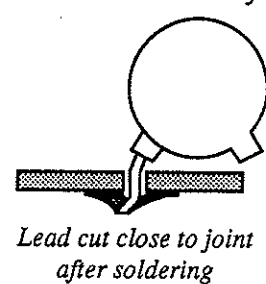
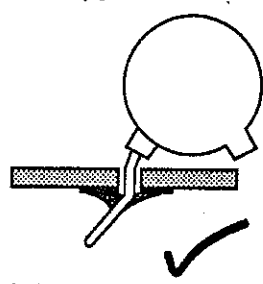
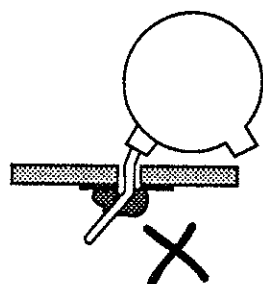
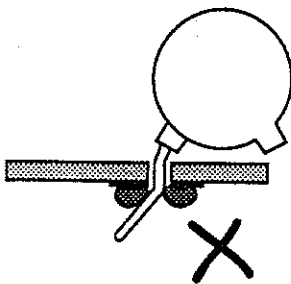

You should hold the hot iron in contact with both the board and component lead for about a second or so to heat them up. Then, keeping the iron in place, touch the solder onto the junction of lead and track and wait a further second or so for the solder to flow along the lead and track to form a good joint. Now remove the iron. The iron should have been in contact with the work piece for a total time of about 4 seconds in all. It is a good idea to drag the tip of the iron up the component lead as you remove it from the joint, this helps to pull any excess solder up with it and encourages good flow along the component lead.

DC2000 Module Wiring

When your DC2000 module is fully assembled you can install it in the case and wire it up. The diagrams on this page show the connections required by the module. The diagram on the left shows theoretical symbols for the connections, whilst the diagram on the right shows the appearance of typical real components. However, your own items may vary from these. If you are using one of our hardware packs to house your project, then refer to the hardware instructions for details of the actual parts supplied with it.

Wire the flexible wire connections first (everything except the tuning capacitor). Then wire up the tuning capacitor connections to the PCB in tinned copper wire (22 SWG recommended).

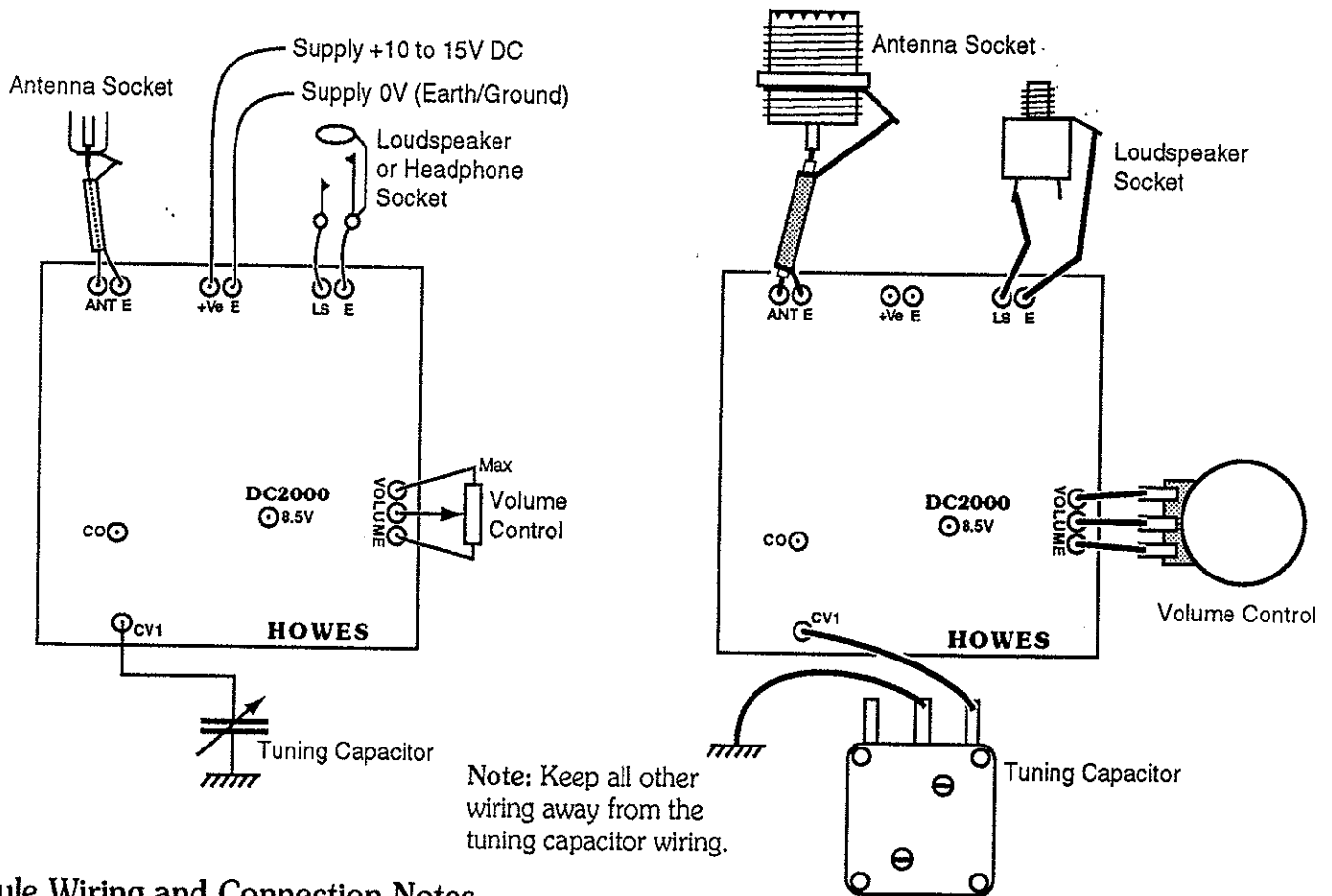

Module Wiring and Connection Notes

Important – you must have some means of limiting the current to the receiver in case of a fault condition. Either a current limited power supply should be used (set to between .5 and 1A), or fit a 1A fuse in the positive supply lead going to the receiver. This fusing is of the utmost importance if you are using a car battery or other source of potentially high currents. For correct protection, the fuse should be fitted at the battery connection end of the wire, not at the receiver end.

If you are going to use accessory kits with your DC2000 (“S Meter”, transmitter etc.), we would recommend you wire up the DC2000 on its own first for testing, and then add the additional wiring/changes for the accessories once you know your receiver is correctly constructed and installed.

“CO” Terminal

The “CO” (counter output) terminal is for connecting a HOWES CBA2 buffer to drive a digital read-out (HOWES DFD5 etc.). Fit the following component values (supplied with CBA2) for this application.

For CBA2 part number R2 use 100R, for CBA2 part number C1 use 3p3.

Connect CBA2 input (“IP”) to “CO” terminal on the DC2000 PCB. These component values and input connection should give consistent buffer output on all bands.

“8.5V” Terminal

This connection provides stabilised +8.5V to power a DT1 fine tune control or other accessory. Only a small current of 10mA or less should be drawn from this terminal.

DC2000 User Information – 1

Power Supply

The DC2000 requires a power source providing between 10 to 15V DC. It should be capable of providing at least 200mA and should be of the regulated type, or a battery. If you wish to purchase a power unit to enable you to run the receiver from the mains, then we recommend you buy a good quality supply giving a regulated 13.8 Volt DC output with a current rating of 4 or 5 Amps. This will be powerful enough to run most equipment, and is a good investment, ready for future additions to your station.

Antenna Requirements

The DC2000 is quite a sensitive receiver and you will normally be able to hear some signals with a few meters of wire connected. However, you will get much better results if you use a decent antenna. The dimensions for a simple wire dipole antenna are shown in the band module instructions. A dipole will give good results without the need for an ATU (antenna tuning unit). If space is limited, then using the longest wire you can connected through an ATU (Howes CTU8 for example) should be quite effective. An active antenna (Howes AA2) is the alternative for locations where other types of antennas are impractical or not desired.

Always keep antennas away from other wiring, especially high voltage power lines, and always disconnect them from the equipment when they are not in use, or in weather conditions that may cause high static voltage discharges (thunder storms etc.).

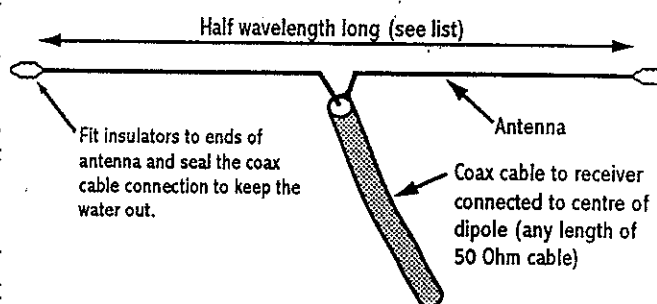
**Loudspeaker or Headphones**

Use an 8 Ohm or higher impedance loudspeaker or headphones. Adjust the volume control for a comfortable listening level as you tune in the stations. There is no automatic gain control in this receiver, so if you wish to use headphones, use ones that are intrinsically incapable of delivering high volume. Exposure to high sound pressure levels can lead to hearing damage over time and should be avoided.

Tuning the Receiver

The DC2000 is a communications receiver for reception of SSB (speech) and CW (Morse) signals. It does not work in the same way, or sound at all like, an AM or FM broadcast receiver. As you tune the main tuning control you will hear a lot of whistles as you tune through stations. Morse signals are quite easy to tune. As you adjust the main tuning control (slowly!) the pitch of the signals changes – simply adjust for a comfortable pitch of the Morse “note” (using the fine tune control if your hardware includes this).

The pitch of SSB speech varies in the same way. As you tune through the signal the pitch varies, but with speech you need to be very accurate in your tuning to get anything like a human sounding voice. This applies to all SSB receivers, it is not peculiar to the DC2000. Learning to tune in SSB signals quickly and easily will take a little practice, if you are new to this. Don't forget that it may be a foreign language or a very poor quality transmission (or both) you are trying to “resolve”! There is some skill required to “drive” a shortwave radio effectively – it will come with practice.

Alignment

If you have bought an assembled band module, it will have been aligned in our test jig. If you have built the module from a kit, you will need to adjust the oscillator coil to set the exact frequency coverage of the radio. You must use a proper insulated trimming tool to adjust the coil. In the band module instructions there is an approximate mechanical setting for the coil's core. Calibrate the end of a matchstick to measure this distance easily. The mechanical setting will get you near to the nominal frequency.

If you use a digital frequency display (Howes DFD5 etc.) you can read the receiver frequency directly. Alternatively a crystal calibrator (Howes XM1) can be used to determine the dial readings, or you can use an already calibrated receiver to set up the DC2000. To do this, link the antenna sockets of the two receivers together and listen for the DC2000's local oscillator signal with the other set (strong!). The local oscillator signal (sounds like a carrier with no modulation) is on the frequency the DC2000 is tuned to. Adjust the band module core for the desired frequency coverage.

DC2000 User Information - 2

Fault finding checklist – try these suggestions if your kit doesn't work.

- 1 Is the battery or power supply you are using OK? Test it on another piece of equipment.
- 2 Is the loudspeaker or headphone properly connected. Can you hear a click when you connect the power to the DC2000? If not recheck these connections again.
- 3 Are all the parts in the right places, are all the diodes etc. the right way round?
- 4 Is anything loose that should not be? Try wiggling everything very gently. If a wire comes away, or a component moves on the PCB, then you have found a poor connection. There may be others, so check all parts.
- 5 When you have done the above and the problem persists or you have found a loose or incorrect part on the PCB, disconnect the power supply and then the wires from the terminal pins on the PCB, take the board out of the case. Recheck all the soldering. All the joints should look bright and shiny, and no light should be visible through any holes when you hold the board up to a bright light. Don't heap extra solder onto everything out of desperation! Only add solder if a joint really needs it. Too much solder will tend to "bridge" across to other tracks, so don't overdo it.
- 6 Reinstall the module but without any additional wiring for optional accessories etc. so that faults in other associated boards or wiring will not affect the receiver.
- 7 We can give telephone advice during office hours, and usually on Saturday too. Please carry out the above checks before 'phoning, because these are the most effective "first aid" suggestions and they should get you up and running in most cases.

Operational Problems

Hum

A steady hum coming from the receiver's loudspeaker is likely to be due to one of two causes. If the hum remains the same when the antenna is disconnected, then the hum is almost certainly coming from the power supply running the receiver. Try a battery instead of the power supply, to prove this is the case. The only answer to this problem is a better power supply with a lower output "ripple" (or use a battery!).

If the hum goes away when you unplug the antenna, then you almost certainly have a case of "modulation hum". This is when the signal from the receiver's VFO is somehow carried into the power supply or mains wiring where it is modulated by the mains frequency. The modulated "hummy" signal is then picked up by the antenna and fed back into the receiver where it is received just like any other signal, except that as it is the receiver's own signal, it is always perfectly tuned in at "zero beat" – you just hear the superimposed hum. Ensuring that the receiver's antenna is kept away from mains wiring will help to avoid this problem. This is why, when you are wiring the receiver into its case, you should also make sure you keep the leads that go to the power supply well away from the signal circuits and especially the tuning capacitor and its wiring.

Winding the leads from the power supply around a ferrite rod or ring is a good way to prevent the VFO signal getting back to the power supply, and is the thing to try if the problem persists after correcting the receiver's wiring and the antenna siting. Due to its low VFO radiation, the DC2000, when correctly installed in a screened case, will be less susceptible to modulation hum than many "straight" receiver designs.

AM Demodulation

All receivers will "overload" at signal strengths above a certain threshold. In direct conversion type receivers overload tends to manifest itself as "AM breakthrough" when strong broadcasting stations can be heard in the background. The range of signal levels that a receiver can cope with is known as its "dynamic range". There are various technical ways to specify this performance, we won't go into the details here, but the DC2000 is good for this class of receiver. For a given dynamic range, the more sensitive a direct conversion receiver is, the lower the signal level that will produce AM breakthrough. We have made the DC2000 a very sensitive little receiver, so that it will work well with very modest antennas. However, this does mean that it will overload more easily on a good antenna than a less sensitive receiver with the same dynamic range. Adding an attenuator in the antenna feed will reduce the sensitivity and raise the overload threshold if you find you need this. The HOWES RA30 is an attenuator kit designed for this type of application.

DC2000 User Information - 3

Circuit Description

The DC2000 circuit is quite simple in concept and the block diagram shows the basic circuit functions in outline.

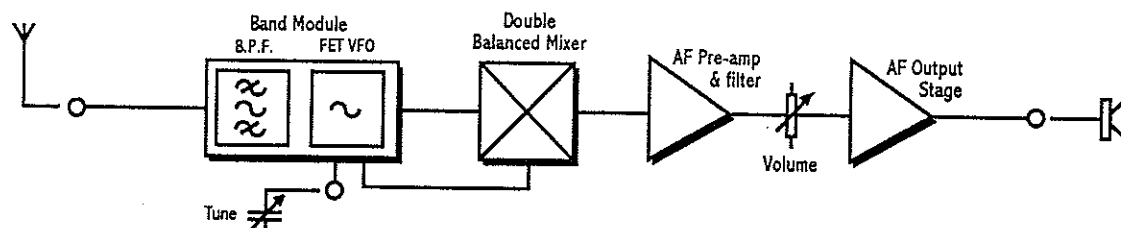

RF stages

The signal from the antenna is fed to the band module where it passes through a bandpass filter to reduce the level of unwanted out-of-band signals. It is then returned to the receiver mother board (via PL1) and fed to the MC1496 mixer (IC1) through an impedance matching transformer, L1. The transformer has a turns ratio of 1:4 (2 turns on the input, 8 on the output winding) this increases the impedance by a factor of 16 (the square of the turns ratio). The mixer is also fed with the signal from the variable frequency oscillator (VFO) on the band module (via PL2).

This oscillator, along with the mixer and audio pre-amplifier (IC2) is supplied with a stabilised voltage of about 8.5V from TR1. The stabilised voltage ensures that the circuit performance will not vary, even if the supply voltage does (within the rated range).

Mixer Stage

The output from the mixer is the result of the interaction between its two inputs, the VFO and the incoming signals. This produces an audio frequency signal, the frequency being equal to the difference between the VFO and signal frequencies. In other words, if the VFO is tuned 1kHz away from the incoming frequency, then a note of 1kHz will be heard. The pitch of the note will alter as the VFO is tuned. This conversion of the incoming signal straight to audio and not via any other (intermediate) frequency gives this type of receiver its name: Direct Conversion.

Audio Stages

The audio frequency (AF) signal from the mixer is amplified by IC2 and then fed to the volume control. After the volume control the signal is further amplified by the audio output stage, IC3. This provides enough signal level to drive a loudspeaker at a decent volume.

Passive Components – resistors and capacitors

Most of the resistors in the circuit are used to set up the correct operating voltages around the ICs. The calculation of the values of these resistors is very important in determining the performance and function of each stage.

The capacitors in the signal path are to pass on the signal to the next stage without letting the DC voltages of one stage affect the operation of the next one. They provide DC isolation. Most of the other capacitors (usually with one connection to earth or chassis) are for “decoupling” purposes. That is, conducting signals to earth (ground) rather than allowing them to pass on to other parts of the circuit where they could cause undesired effects. Sometimes a combination of resistors and capacitors is used (as in the DC voltage feed to the band module) to give extra decoupling efficiency. The resistor makes it harder for the signals to travel along the supply “rail” and the capacitors offering them an easier route (to earth).

Design

The design of good kit equipment is not just about electronic components and circuitry, but also about ease of construction, alignment, test equipment requirements, clarity of instructions, tidy board layout etc. We hope you will find your DC2000 to be just as effective in these departments, as well as being a great little receiver!

DC2000 Circuit Diagram

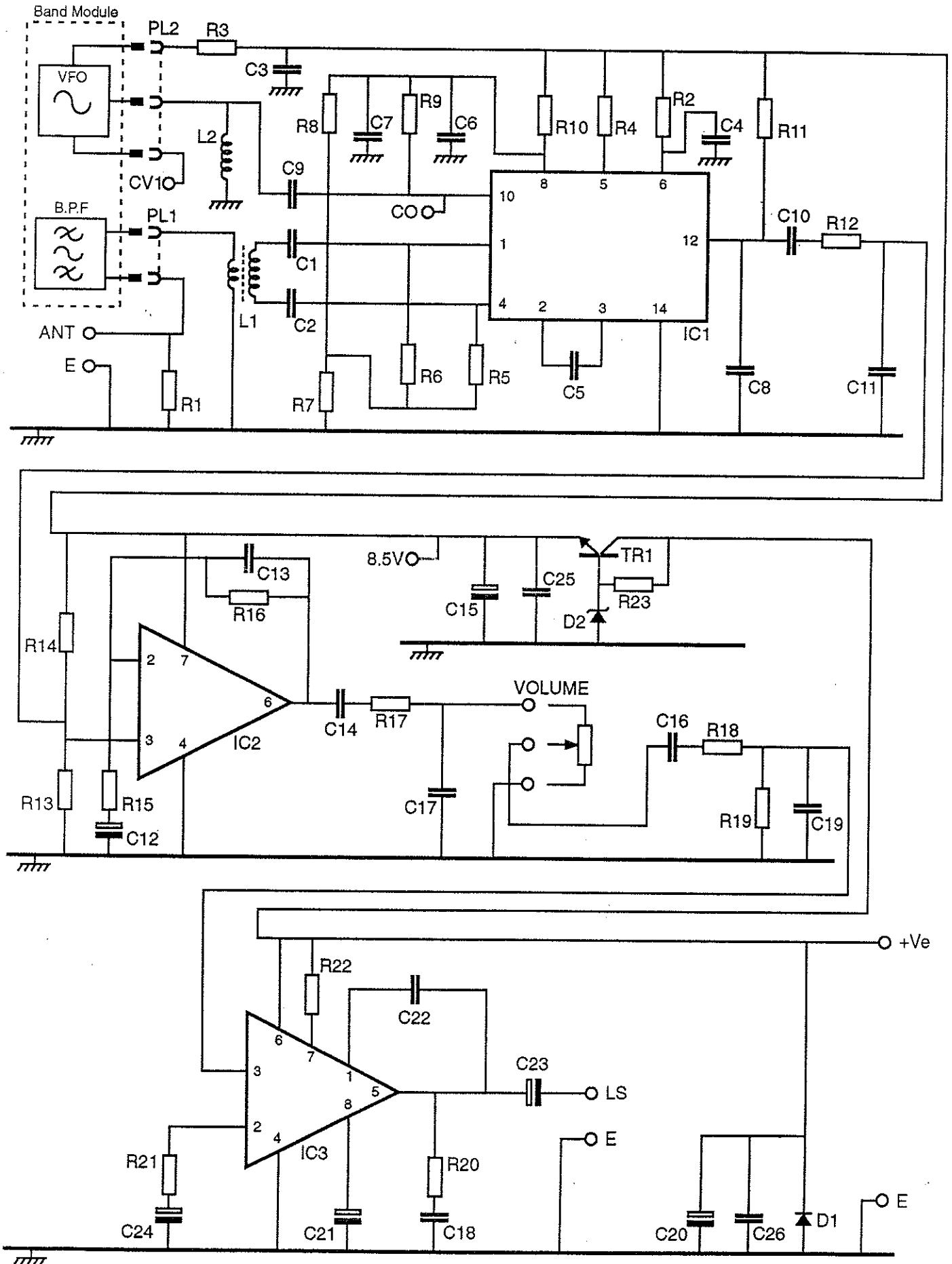

C.M.HOWES COMMUNICATIONS

HA22R Hardware Pack Instructions

Hardware pack for use with **HOWES DC2000** Receiver kit

Parts List

| | |
|----------------------------------|---|
| 1 off HA22R chassis | 1 off HA22R cover |
| 1 off DT1 Fine Tune Kit | 4 off No.4 self tapping screws |
| 4 off M3 12mm pan head bolts | 15 off M3 nuts |
| 1 off M2.5 12mm pan head bolt | 2 off M2.5 6mm pan head bolt |
| 1 off solder tag | 1 off small grommet |
| 1 off SO239 antenna sockets | 1 off 3.5mm jack socket |
| 4 off self adhesive feet | 1 off tuning capacitor with spindle extension |
| 2 off push-on knobs | 1 off large screw fitting knob |
| 1 off multicoloured ribbon cable | 1 off RG174 miniature coax |
| 1 off 22swg tinned copper wire | |

WARNING: Do not try to fit the tuning capacitor's fixing screws to this component before reading the instructions. This component can be irreparably damaged by screwing these bolts in too far.

Tools Required

Medium cut flat file for rounding corners of case. Screwdriver and spanner for M3 nuts and bolts. Centre punch. Small hacksaw. Drill for drilling chassis with the following size drill bits: 2, 2.5, 4 & 7mm.

Pre-assembly Preparation

Before your hardware can be bolted together, there are a few jobs to do first. There is the small DT1 kit to assemble for the Fine Tune control circuit and some pre-assembly metalwork as follows:-

Use a file to round off the corners of the rear panel and the cover. Round them to match the front panel corners which have already been done for you.

Cover Fixings

Position the cover in place on the chassis, and decide how much overlap you like at the front. Equal overlap of the front and rear panels looks quite good. Hold the cover in position, and mark the chassis through the four fixing holes. Centre punch the marks and drill the four positions with a 2.5mm drill bit (to take the No.4 self tap screws).

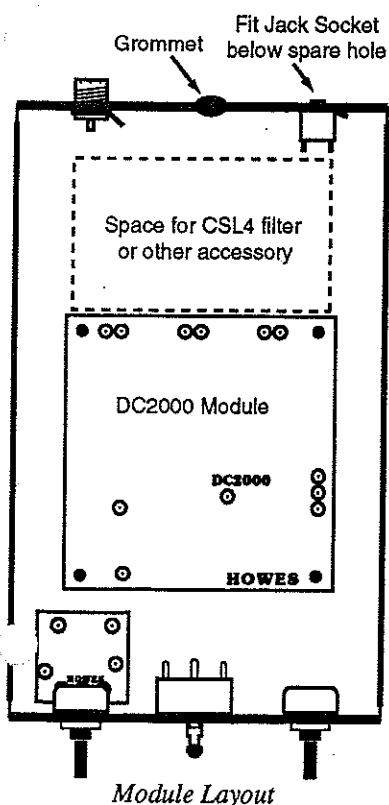

A Battery Power Option to Consider

As supplied, the HA22R hardware with the DT1 Fine Tune control assumes the use of an external power source that can be disconnected when the receiver is not in use. However, there is room behind the DC2000 module to fit an internal battery pack, if you wish to do this for portable operation. If this idea appeals, then it is suggested that you might like to consider replacing the "ON" indicator LED fitted to the front panel (which takes about 3mA) with an on/off toggle switch. If you intend to do this, then you will need to carefully drill out the LED hole to a suitable size. The position of the toggle switch can then indicate when the receiver is on, rather than the LED, which consumes current.

Rear Panel

We have already punched the SO239 socket hole for you (plus a spare hole to take a 5 pin DIN socket for linking to a transmitter). You need to drill two 7mm holes, one for the power cables' grommet (if you are going to use an external power source), and one for the loudspeaker/headphone socket. Drill the jack socket hole below the one for the optional DIN socket. If you are going to add a linking module or audio filter to your receiver, then you may need to add holes for extra switches on this panel as well.

HOWES

HA22R Instructions 2

Drilling the Chassis to take the PCB Module

Arrange the DC2000 PCB module in place on the chassis as shown in the diagram on page 1. The front edge of the DC2000 should be approx. 38 mm (1.5") behind the rear of the front panel to allow for mounting the controls. The edge of the module should be about 20mm in from the left hand side of the chassis. Mark the chassis through the PCB fixing holes using a felt tip pen. Remove the module, centre punch the chassis where you have marked it and then drill with 2mm pilot holes first, then enlarge the holes to 4mm. If you are going to add an accessory kits, such as the CSL4 audio filter, then this should be fitted behind the DC2000 in a similar manner. Peel off the thin protective plastic from the chassis when the drilling is complete.

Feet

Stick the self-adhesive feet neatly in position on the base of the chassis, one near each corner of the case.

Tuning Capacitor

The tuning capacitor needs to have its spindle extension fitted, and to then be mounted behind the front panel.

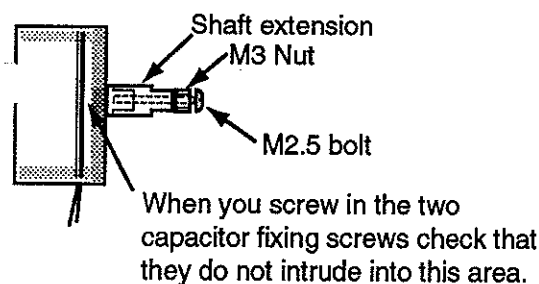

Important:- you must only fit the fixing screws to the capacitor once it is in place behind the panel, and the M3 nuts are on the fixing bolts to act as spacers. Without the panel and spacers, the screws could enter too far into the body of the capacitor and damage its internal workings.

Fit the brass spindle extension to the capacitor using the 12mm length M2.5 bolt with one M3 nut on the bolt to act as a spacer (see diagram on left).

Fit the capacitor in its position behind the panel with its leads at the bottom. Use the 6mm length M2.5 bolts to fix it in place, each bolt being fitted with one M3 nut as a spacer. Do not tighten these bolts more than just enough to hold the capacitor in place. The diagram on the right shows the assembly.

When the tuning capacitor is fitted to the front panel, rotate the trimmers on its rear to the positions as shown in the diagram below. This sets them to minimum capacitance, as they are not needed in this application.

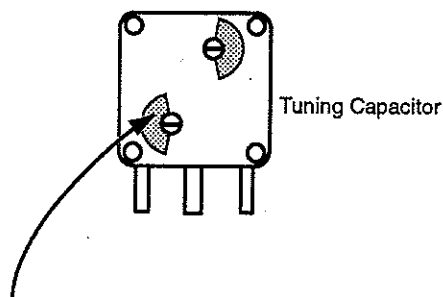
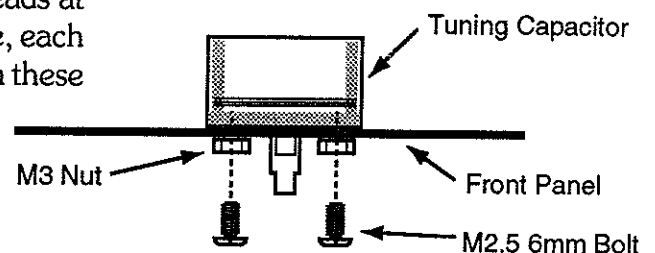

Rotate the two trimmers on the capacitor to the positions shown (use a screwdriver)

Rotate the capacitor fully anticlockwise, and fit the large knob to it with the indicator spot aligned with the base line on the left. If the knob sits at an odd angle on the capacitor shaft, you may need to reposition the spindle extension spacer nut to straighten it (slacken the M2.5 12mm bolt slightly, move the nut round a fraction, and retighten the bolt). Check the knob turns without scraping on the panel, and the white spot follows the scale from end to end.

Fine Tune and Volume pots

Cut the spindles of these two controls down to a length of about 10mm. To do this hold the end of the spindle in a vice, or over the edge of the bench and cut the spindle with a small hacksaw.

DT1 Fine Tune Control PCB

Before fitting the Fine Tune pot, you will need to assemble the DT1 PCB module from the kit provided (the DT1 PCB module needs to be soldered to the pot before the pot is fitted to the front panel).

Mounting the Pots

Fit the Volume pot to the panel with its solder tags at the bottom and the crinkle washer behind the panel. Do not overtighten the fixing nut. When the DT1 PCB has been assembled, checked and soldered to the pot's solder tags, fit the Fine Tune control behind the panel in the same manner as the Volume control.

HA22R Instructions 3

Push-on Knobs

The push-on knobs should be fitted to the two control pots. Remove the knob caps, if these are already in the knobs (use your finger nails or a thin tool), and position them so that they line up with the panel markings by turning the controls fully anticlockwise and then pushing the caps in so that their white lines align with the most anticlockwise line printed on the panel.

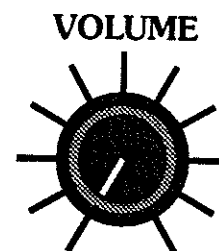

Volume at minimum

Mounting the DC2000 Module

The DC2000 PCB module is spaced off the chassis on M3 nuts as shown in the diagram. Make sure you have trimmed the leads of all the components short enough so that they are not going to touch the chassis. Neat soldering and trimming of component leads should ensure that one spacer nut is sufficient. If you feel that you may need a second spacer nut to ensure clearance, then fit additional ones, we have included enough to do this.

Fit the small solder tag to the front left hand PCB fixing bolt, above the PCB.

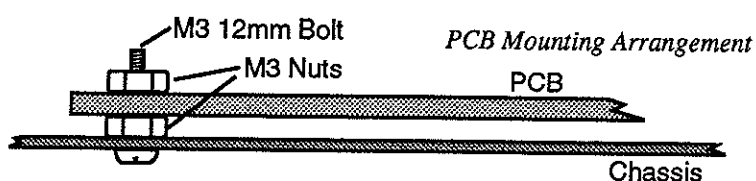

Sockets

Fit the sockets in place on the rear panel. The SO239 coax socket is inserted from the outside of the chassis with the fixing nut screwed on from behind the panel. The socket's solder tag is fitted under the fixing nut. Once the nut is tightened, the solder tag should be bent slightly away from the panel so that you can solder to it. The 3.5mm jack socket is inserted from inside the chassis and the nut screwed on from the outside. If you are fitting the LM2000 linking module, then also fit the 5 pin DIN socket.

Wiring

You can now wire up the DC2000 module as shown in the diagrams (kit instruction "module wiring" page and on page 4 of these instructions).

The PCB fixings connect the module to chassis. All four corner mountings must be used, and tightened up, to connect the module properly to the case.

To avoid some wires getting in the way of soldering other connections, it is suggested that you wire up the unit in the order set out below.

Wire the tuning capacitor centre lead and the DT1 "E" terminal pin to the solder tag using a length of the 22swg tinned copper wire supplied. Use another length of this wire to connect the capacitors right hand tag to the "CV1" terminal on the DC2000 and to "CV1" on the DT1 PCB.

Wiring the Coax Socket.

Use the short length of miniature coax supplied to connect the antenna socket to the DC2000's "ANT" and adjacent "E" connections as shown in the diagrams, but please read the paragraphs below first!

SO239 coax sockets are not the easiest of things to solder properly. We supply this type of connector because they are the standard on most amateur radio equipment, not for their ease of soldering! The best way to solder to this is to make sure the connection points are clean by scraping them with a sharp knife, and then tin them using a soldering iron with a reasonable amount of power behind it. Anything less than 25W is unlikely to make a good connection — a higher powered device is useful if you have one. After tinning the connection points well, offer up the coax cable (also pre-tinned) and then reflow the solder to make the joints.

Note: Do not attempt to solder the coax to the connector without first tinning the socket, otherwise the length of time it will take to get the solder to flow on the socket in the first instance, will almost certainly melt the insulation on the coax, and probably lead to a short circuit in the cable.

HA22R Overall Wiring Diagram

Ribbon Cable

Multicoloured ribbon cable is provided for wiring the other connections. Peel off a strip of three wires from the ribbon (e.g. black, white and grey). Separate the ends of the wires for about 15mm and then strip the insulation from the last 3mm at the ends ready for soldering. Tin the ends of the wires (apply some solder to them) and then use them to connect the "Volume" pot to its PCB terminals (see wiring diagrams for details).

Peel a pair of wires from the ribbon (e.g. violet and blue), prepare the cable ends as before, and use them to connect the "LS" and adjacent "E" terminal to the jack socket as shown in the diagram.

Peel off two separate wires from the ribbon, (e.g. red and brown). Use one (red) to connect the "8.5V" terminals on the DT1 and the DC2000 PCBs together.

LED Mounting

Tin a spot on top of the Volume pot's case, then trim and solder the shorter of the two LED's leads to the spot you have tinned (see diagram). Use the remaining single wire (brown) to link "L" on the DT1 PCB to LED's longer lead (which should be trimmed short before soldering). This completes the internal wiring of the basic receiver. You now need to connect up some power supply leads and test your handiwork! Don't forget to plug in the antenna module!

Checking your Wiring

The diagram on the right shows the overall wiring connections for the DC2000 when installed in the HA22R hardware.

Note: The diagram shows the module viewed from above, and the rear view of the front and back panels, as though they had not been folded into their normal vertical position. The drawing is not done to an exact scale.

Finishing your Project

To complete the good looks of your project, you can paint the cover to match your other equipment, or any colour you choose. A satin finish tends to look better than gloss or matt, and does not show the finger marks so much! Satin black acrylic car paint is used on our demonstration equipment (over a coat of primer). If you don't like using spray paints,

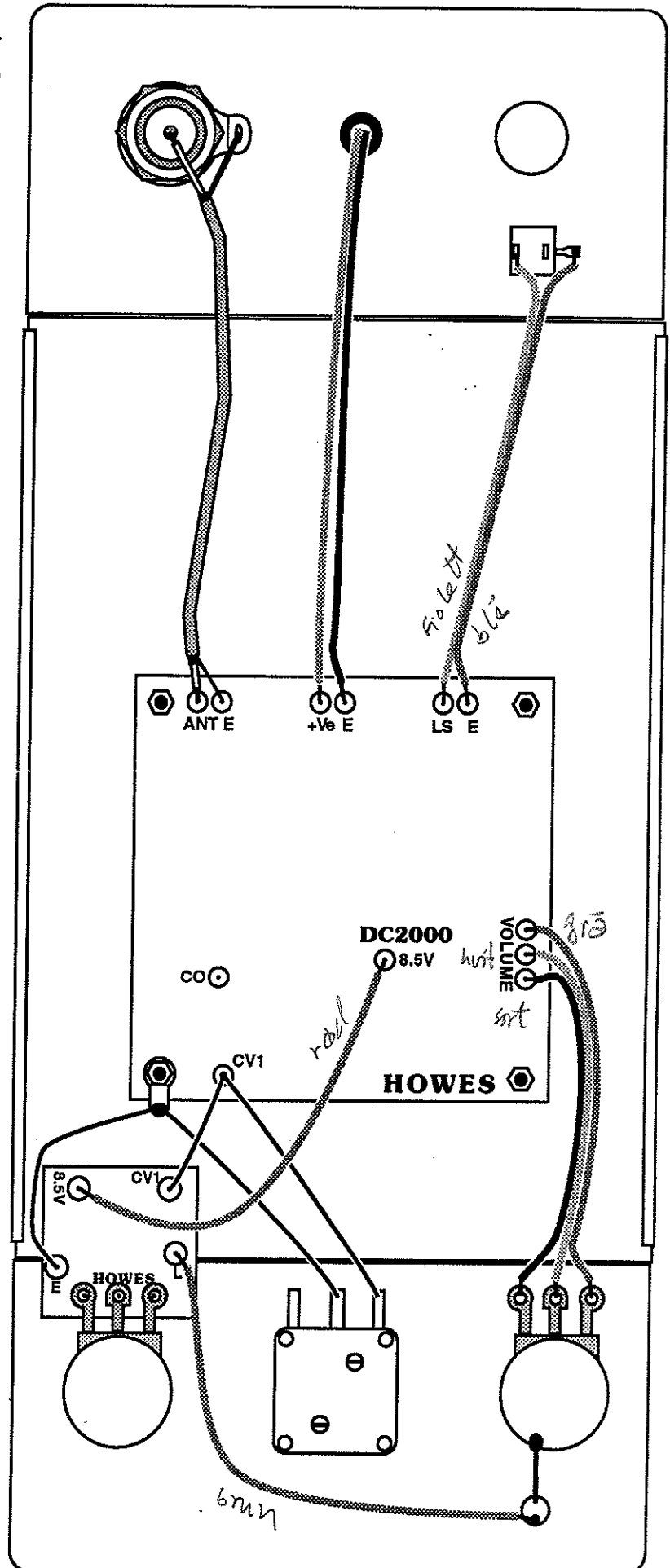

HA22R User Notes

en a very effective finish can be obtained by covering the cover with "Fablon" or other thin self-adhesive plastic decorative material obtainable from DIY shops.

Operating the Finished Unit

Refer to the DC2000 instructions for more information about using the receiver. These notes give a quick recap of the basic operation.

Volume Control

Adjust the Volume control for a comfortable listening level. There is no automatic gain control in this receiver, you will need to adjust the volume manually for different stations. If you wish to use headphones, only use ones that are intrinsically incapable of high sound pressure levels. Hearing damage can result from exposure to high sound levels over time.

Main and Fine Tune Controls

Use the central Main Tuning control to find stations on the band. First, set the Fine Tune to midway and then tune slowly across the band with the Main Tune. When you are roughly tuned to a signal, use the Fine Tune control to tune it in accurately.

Note: If the receiver is tuned to the "wrong side" of an SSB signal it will not "resolve" (be intelligible), so you may need to tune through to the other side of an SSB signal to make out what is being said. SSB signals are normally lower sideband on the 160, 80 and 40 meter amateur bands, and upper sideband on everything else. You need to adjust your tuning technique to take this into account when you swap band modules to a band using the "inverted" mode.

Dial Scale

The HA22R front panel is scaled for 160, 80 and 20M bands (1.8 to 2.0, 3.5 to 3.8 and 14.0 to 14.35MHz respectively). A logging scale (effectively 0 to 10, but not numbered) is closest to the knob for guidance on other bands. Frequency / logging scale relationships for some popular bands are set out below. The logging scale counts from 0 to 10 clockwise. The 10 and 40M bands are shown for two settings of their band module adjustment, one starting at the bottom of the band for CW and one for the main SSB section.

| Module: BM10 | |
|---------------------|-------|
| Frequency | Scale |
| 28.0 | 0 |
| 28.1 | 3 |
| 28.2 | 5 |
| 28.3 | 7 |
| 28.4 | 8.5 |

| Module: BM10 | |
|---------------------|-------|
| Frequency | Scale |
| 28.4 | 0 |
| 28.5 | 3 |
| 28.6 | 5 |
| 28.7 | 6.8 |
| 28.8 | 8.3 |

| Module: BM15 | |
|---------------------|-------|
| Frequency | Scale |
| 21.0 | 0 |
| 21.1 | 3 |
| 21.2 | 5 |
| 21.3 | 6.5 |
| 21.4 | 7.8 |
| 21.5 | 9 |

| Module: BM30 | |
|---------------------|-------|
| Frequency | Scale |
| 10.10 | 0 |
| 10.11 | 1.9 |
| 10.12 | 3.4 |
| 10.13 | 4.7 |
| 10.14 | 5.7 |
| 10.15 | 6.8 |

| Module: BM40 | |
|---------------------|-------|
| Frequency | Scale |
| 7.00 | 0 |
| 7.01 | 3.1 |
| 7.02 | 5.4 |
| 7.03 | 7 |
| 7.04 | 8.6 |

| Module: BM40 | |
|---------------------|-------|
| Frequency | Scale |
| 7.05 | 0 |
| 7.06 | 3.2 |
| 7.07 | 5.4 |
| 7.08 | 7 |
| 7.09 | 8.8 |

DT1 Instructions

The HOWES DT1 is a fine tune control for use in parallel with the normal 50pF tuning capacitor as used in many of our kits. It enables the frequency to be adjusted by a small amount, to make exact tuning easier. It is supplied as standard with the HA22R hardware pack.

Caution: Please be careful not to mix up the parts in this kit with the parts from other kits you may have.

Brief Technical Details

Frequency Coverage: Dependent on the range being tuned by the main tuning capacitor. The DT1 will give approximately 2.3% variation of the tuning range provided by a nominal 50pF tuning capacitor. The tuning rate is roughly equivalent to having a 60:1 ratio reduction drive on the main tuning control.

Power Required: the DT1 is designed to operate from a nominal +8.5V stabilised supply taken from the associated receiver/VFO etc. A light emitting diode (LED) is provided for "power on" indication. Total current consumption of DT1 with LED connected is approx. 4mA.

Building The Kit

These are very brief instructions simply giving the details of which parts go where on the DT1 PCB. Please refer to your main kit instructions for more details on soldering, drawings to help identify component types, and general assembly techniques.

The suggested assembly order is to fit the terminal pins (to holes with circles around them), followed by the fixed resistors, the diode and the capacitors. Make sure you fit the diode the right way round – see diagram below. Finally the PCB is connected to the control pot ready for installation. Take care to connect the LED correctly when you wire it up. It won't light if the connections are reversed.

Parts List

| Part | Marking/Colour Code |
|---|------------------------------|
| Resistors R1 & R2 (100k Ω) | Brown, Black, Yellow, Gold |
| R3 (3k3) | Orange, Orange, Red, Gold |
| Capacitor C1 (.1 μ F) | 104 (disc type) |
| C2 (5.6pF) | 5p6 (plate type) |
| Diode D1 | 1N4004, black with grey band |

Circuit Diagram

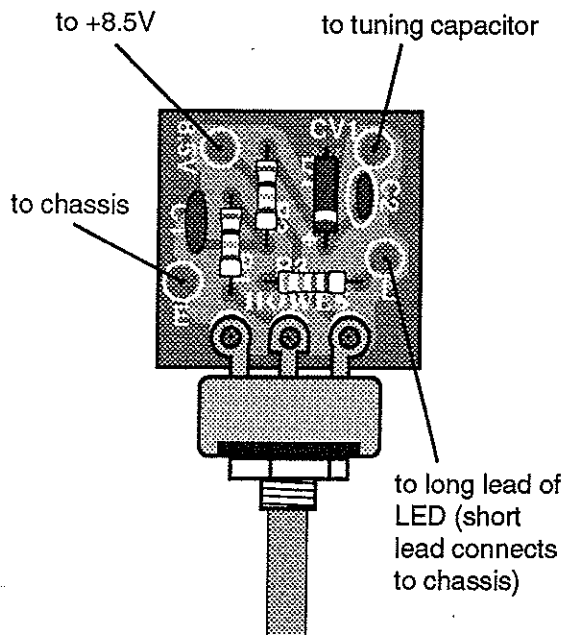
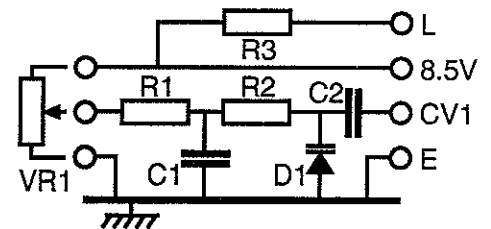

Control pot fitted to DT1 PCB
viewed from above

Fitting the Control Pot

Very carefully bend the solder tags of the pot backwards so that they are at right angles to the body of the component. Take care that their crimped connections to the pot itself are not loosened as you do this. When this is done, fit the solder tags over the terminal pins on the PCB as shown in the diagram. Cut down the length of the centre terminal pin to ensure it won't touch the back of the pot. Then solder the tags to the terminal pins. These electrical connections also provide the mechanical mounting for the module, so make sure the joints are well made.

The fine tune control can now be installed in the equipment's case and wired up. The connections are quite straightforward and are shown in the diagram. Make sure that the DT1 board is spaced off the chassis sufficiently so that it won't "short" to the metalwork. Don't forget that when you make the connection to the main tuning capacitor, you still have to connect the capacitor to its connection point on the main PCB (receiver/VFO etc.).

BM80 Instructions

The **HOWES BM80** is a plug-in tunable band module for use with a **HOWES DC2000** and **DXR20** direct conversion receivers to give coverage of the 80M amateur band or other frequencies between 2.4 and 3.9MHz.

Brief Technical Details

Frequency Coverage: Approx. 3.5 to 3.8MHz with a 50pF tuning capacitor. This module can also be set to cover other frequencies between 2.4 & 3.9MHz.

PCB type BMV with 8 pole RF band-pass filter & FET VFO.

Building The Kit

These are very brief instructions simply giving the details of which parts go where on the band module PCB. Please refer to your receiver kit instructions for more details on soldering, drawings to help identify component types, and general assembly techniques.

The suggested assembly order is to fit the resistor, followed by the axial inductors (these look like fatter resistors), the diode, capacitors, the wire link (note – only fit one link), variable inductor, the sockets and finally the transistor. The diode and transistor must be fitted the right way round. Keep all component leads as short as possible. Mark the band on the module with a spirit based felt tip pen, so you know which it is!

Parts List

| Part | Marking/Colour Code |
|---|---|
| ✓ Resistor R1 (100kΩ) | Brown, Black, Yellow, Gold |
| ✓ Axial Inductors, L1, L2, L3 & L4 | Red, Violet, Gold, Silver |
| ✓ Diode D1 | 1N4148 (usually orange with black band) |
| Capacitors C1 & C3 (1.2nF) | 1n2 (plate type) |
| ✓ C2 (1.8nF) | 1n8 (plate type) |
| ✓ C4 (680pF) | n68 (plate type) |
| C5 (.1μF) | 104 (disc type) |
| C6 (22pF) | 22 (disc type) |
| C7 (330pF) | 330 (silver coloured) – mount this vertically |
| C8 (1nF) | 1n (silver coloured) – mount this vertically |

Link LKA. Use an offcut capacitor lead to link the two PCB holes indicated. Only fit one link to the board. Fitting LKB and not LKA would give much reduced frequency coverage.

Variable Inductor L5 (VFO coil).

This is marked K4921 on its side (amongst other numbers).

Sockets SK1 & SK2. These have little plastic mouldings that wrap around the edge of the board, the terminals then slide into their holes for soldering.

Transistor TR1. Marked BF245A. Fit this the right way round as indicated by the outline on the PCB.

Alignment for 3.5 to 3.8MHz

Adjust the core of L5 using an insulated trimming tool so that the top of the core is about 4mm below the top of the screening can. Then, plug the module into your receiver (with the power off), and make a final VFO alignment in the manner described in the receiver kit instructions.

Antenna Information:

The total length of a wire half-wave dipole antenna for 3.6MHz is approx. 39.58M. If a dipole is too big for your location, use as long a wire as you can in conjunction with an antenna tuning unit (HOWES STU8 etc.). A tuned antenna will help reject spurious signals. 40M signals are often very strong at night, and can sometimes be tuned by the harmonic of the oscillator.

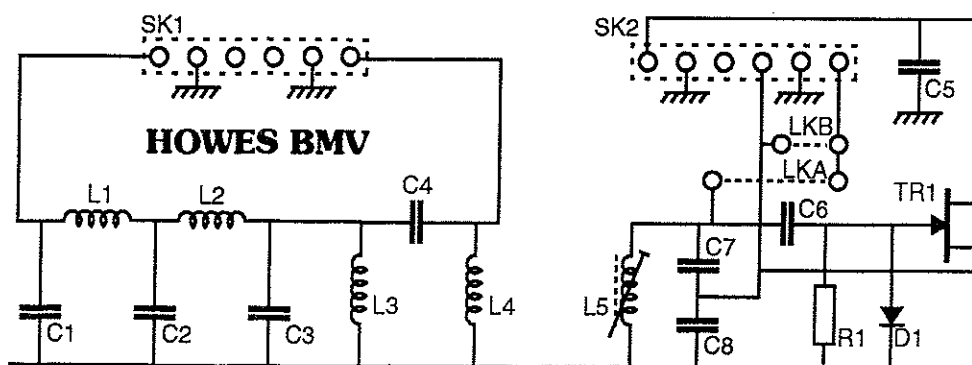

BM20 Instructions

The **HOWES BM20** is a plug-in tunable band module for use with the **HOWES DC2000** and **DXR20** receivers to give coverage of the 20M amateur band or other frequencies between 12.4 and 17.5MHz.

Brief Technical Details

Frequency Coverage: Approx. 14.0 to 14.33MHz with a 50pF tuning capacitor in DXR20, 14.0 to 14.36 in DC2000/HA22R. This module can also be set to cover other frequencies between 12.4 & 17.5MHz.

PCB type BMV with 8 pole RF band-pass filter & FET VFO.

Building The Kit

These are very brief instructions simply giving the details of which parts go where on the band module PCB. Please refer to your receiver kit instructions for more details on soldering, drawings to help identify component types, and general assembly techniques.

The suggested assembly order is to fit the resistor, followed by the axial inductors (these look like fatter resistors), the diode, capacitors, the wire link (*note* – only fit one link), variable inductor, the sockets and finally the transistor. The diode and transistor must be fitted the right way round. Keep all component leads as short as possible. Mark the band on the module with a spirit based felt tip pen, so you know which it is!

Parts List

| Part | Marking/Colour Code |
|---|---|
| ✓ Resistor R1 (100kΩ) | Brown, Black, Yellow, Gold |
| ✓ Axial Inductors, L1, L2, L3 & L4 | Yellow, Violet, Silver, Silver |
| ✓ Diode D1 | 1N4148 (usually orange with black band) |
| ✓ Capacitors C1 & C3 (270pF) | n27 (plate type) |
| ✓ C2 (680pF) | n68 (plate type) |
| ✓ C4 (180pF) | 181 (disc type) |
| ✓ C5 (.1μF) | 104 (disc type) |
| ✓ C6 (22pF) | 22 (disc type) |
| ✓ C7 (220pF) | 220 (silver coloured) – mount this vertically |
| ✓ C8 (330pF) | 330 (silver coloured) – mount this vertically |

✓ **Link LKB.** Use an offcut capacitor lead to link the two PCB holes indicated. Only fit one link to the board. Fitting LKA and not LKB would give much wider frequency coverage, and lose bandspread.

✓ **Variable Inductor L5** (VFO coil). This is marked K1731 on its side (amongst other numbers)

✓ **Sockets SK1 & SK2.** These have little plastic mouldings that wrap around the edge of the board, the terminals then slide into their holes for soldering.

Transistor TR1. Marked BF245A. Fit this the right way round as indicated by the outline on the PCB.

Alignment.

Adjust the core of L5 using an insulated trimming tool so that the top of the core is approximately 3mm below the top of the screening can. Then, plug the module into your receiver (with the power off), and make a final VFO alignment in the manner described in the receiver kit instructions.

Antenna Information:

The total length of a wire half-wave dipole antenna for this band is approx. 10.0M.

